

Nulacvi

2024  
**CITY LINE**  
MANILLONES

London Led	3
London	4
Dublín desplazado	5
Berlín	6
Bristol desplazado	7
Sidney	8
Shanghay	9
Miami	10
Berna	11
Kit accesorios	12
Manillón Modelo 7006	13
Modelo 7003 con placa estrecha	14
Modelo 7001 con placa estrecha	15
Pomos de Puerta	16
Rosetas con bocallave y accesorios	17
Pomos con placa y con roseta	18

# London Led

6104.D4.20

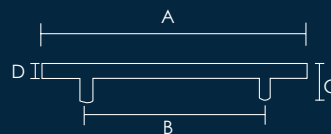

6 luces Led

6 luces Led

Sensor detector de movimientos

Sistema Led alimentado por 4 pilas AA

REFERENCIA	CONCEPTO	A	B	C	D
6104.D2.20	Manillón Led / <i>Led Light Pull Handle</i>	400	200	80	20
6104.D3.20	Manillón Led / <i>Led Light Pull Handle</i>	600	400	80	20
6104.D4.20	Manillón Led / <i>Led Light Pull Handle</i>	1000	600	80	20
6104.D6.20	Manillón Led / <i>Led Light Pull Handle</i>	1800	1400	80	20

ACABADOS / FINISHES  
Acero Inoxidable (20)

# London

6104.U2.34

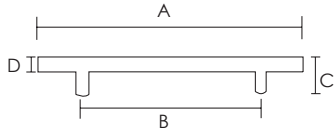

6104.U3.20



6104.L3.20

REFERENCIA	CONCEPTO	A	B	C	D
6104.L2	Juego de Manillones Mod. London /Set pull handle Mod. London	400	200	80	30
6104.L3	Juego de Manillones Mod. London /Set pull handle Mod. London	600	400	80	30
6104.L4	Juego de Manillones Mod. London /Set pull handle Mod. London	1000	600	80	30
6104.L5	Juego de Manillones Mod. London /Set pull handle Mod. London	1400	1200	80	30
6104.L6	Juego de Manillones Mod. London /Set pull handle Mod. London	1800	1400	80	30
6104.U2	Manillón Mod. London /Pull handle Mod. London	400	200	80	30
6104.U3	Manillón Mod. London /Pull handle Mod. London	600	400	80	30
6104.U4	Manillón Mod. London /Pull handle Mod. London	1000	600	80	30
6104.U5	Manillón Mod. London /Pull handle Mod. London	1400	1200	80	30
6104.U6	Manillón Mod. London /Pull handle Mod. London	1800	1400	80	30

## ACABADOS / FINISHES

Acero Inoxidable (20), Negro Mate (34)

# Dublín



6124.L4.20



6124.U4.34

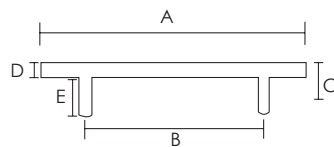

REFERENCIA	CONCEPTO	A	B	C	D	E
6124.L2	Jgo. de Manillones desplazados Dublín / <i>Displaced set pull handle Dublín</i>	400	200	58	30	85
6124.L3	Jgo. de Manillones desplazados Dublín / <i>Displaced set pull handle Dublín</i>	600	400	58	30	85
6124.L4	Jgo. de Manillones desplazados Dublín / <i>Displaced set pull handle Dublín</i>	1000	600	58	30	85
6124.U2	Manillón desplazado Mod. Dublín / <i>Displaced pull handle Mod. Dublín</i>	400	200	58	30	85
6124.U3	Manillón desplazado Mod. Dublín / <i>Displaced pull handle Mod. Dublín</i>	600	400	58	30	85
6124.U4	Manillón desplazado Mod. Dublín / <i>Displaced pull handle Mod. Dublín</i>	1000	600	58	30	85

## ACABADOS / FINISHES

Acero Inoxidable (20), Negro Mate (34)

# Berlín



**7104.U2.34**



**7104.L2.20**

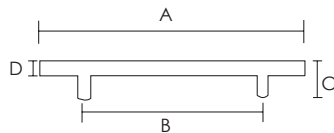

REFERENCIA	CONCEPTO	A	B	C	D
7104.L2	Juego de Manillones Mod. Berlín / <i>Set pull handle Mod. Berlin</i>	400	200	80	25x25
7104.L3	Juego de Manillones Mod. Berlín / <i>Set pull handle Mod. Berlin</i>	600	400	80	25x25
7104.L4	Juego de Manillones Mod. Berlín / <i>Set pull handle Mod. Berlin</i>	1000	600	80	25x25
7104.L5	Juego de Manillones Mod. Berlín / <i>Set pull handle Mod. Berlin</i>	1400	1200	80	25x25
7104.L6	Juego de Manillones Mod. Berlín / <i>Set pull handle Mod. Berlin</i>	1800	1400	80	25x25
7104.U2	Manillón Mod. Berlín / <i>Pull handle Mod. Berlin</i>	400	200	80	25x25
7104.U3	Manillón Mod. Berlín / <i>Pull handle Mod. Berlin</i>	600	400	80	25x25
7104.U4	Manillón Mod. Berlín / <i>Pull handle Mod. Berlin</i>	1000	600	80	25x25
7104.U5	Manillón Mod. Berlín / <i>Pull handle Mod. Berlin</i>	1400	1200	80	25x25
7104.U6	Manillón Mod. Berlín / <i>Pull handle Mod. Berlin</i>	1800	1400	80	25x25

## ACABADOS / FINISHES

Acero Inoxidable (20), Negro Mate (34)

# Bristol



7124.U3.34

7124.L3.20

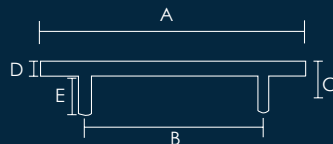

REFERENCIA	CONCEPTO	A	B	C	D	E
7124.L2	Juego de Manillones desplazados Bristol / Displaced set pull handle Bristol	400	200	45	30	62
7124.L3	Juego de Manillones desplazados Bristol / Displaced set pull handle Bristol	600	400	45	30	62
7124.L4	Juego de Manillones desplazados Bristol / Displaced set pull handle Bristol	1000	600	45	30	62
7124.U2	Manillón desplazado Mod. Bristol / Displaced pull handle Mod. Bristol	400	200	45	30	62
7124.U3	Manillón desplazado Mod. Bristol / Displaced pull handle Mod. Bristol	600	400	45	30	62
7124.U4	Manillón desplazado Mod. Bristol / Displaced pull handle Mod. Bristol	1000	600	45	30	62

## ACABADOS / FINISHES

Acero Inoxidable (20), Negro Mate (34)

# Sidney



6101.U2.25

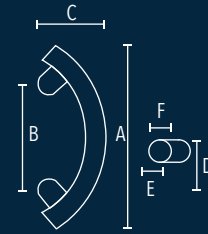

REFERENCIA  
6101.U2.25

CONCEPTO  
Manillón Sidney / *Pull handle Sidney*

A	B	C	D	E	F
610	430	120	75	32	32

ACABADOS / FINISHES  
Acero Brillo / Acero Inoxidable (25)



# Shanghai

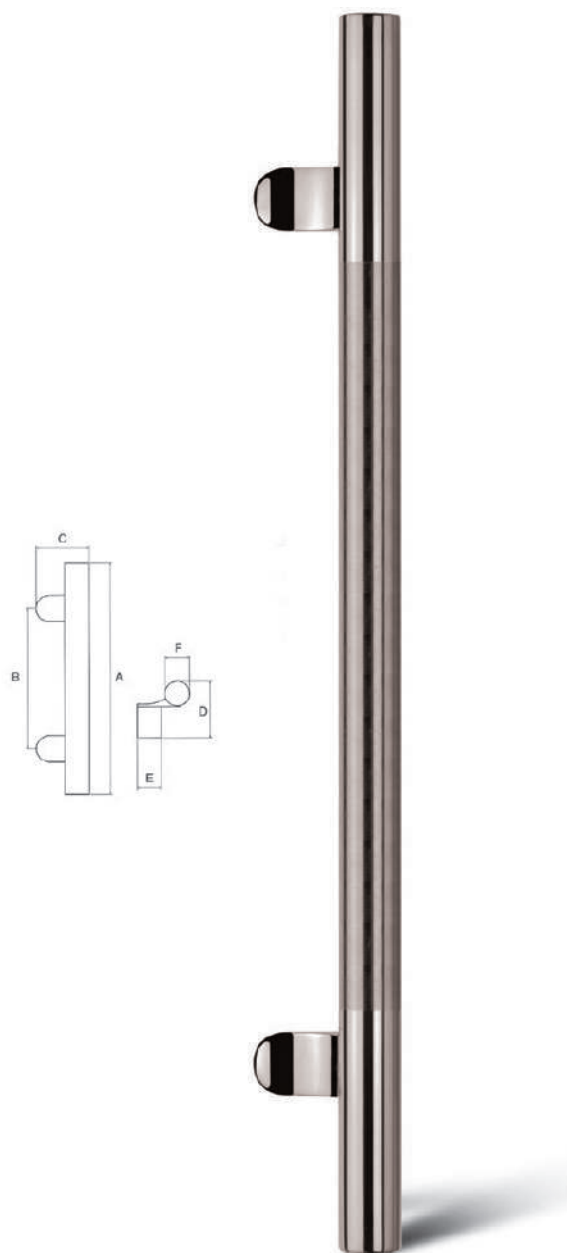

REFERENCIA	A	B	C	D	E	F
6105.U2	400	250	76	75	32	32
6105.U3	600	425	76	75	32	32
6105.U4	1000	700	76	75	32	32
6105.U6	1800	1400	76	75	32	32

ACABADOS / FINISHES  
Acero Brillo/Acero Inoxidable (25)

# Miami

6114.U2.25



REFERENCIA  
6114.U2.25

CONCEPTO  
Manillón Miami / *Pull handle Miami*

A	B	C	D
610	430	120	32

ACABADOS / FINISHES  
Acero Inoxidable brillo (25)

# Berna

---

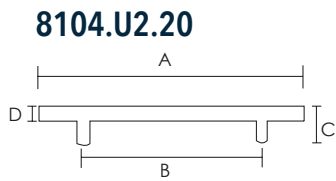





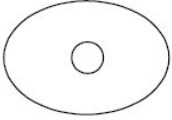
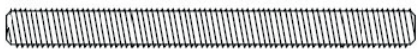

REFERENCIA	CONCEPTO	A	B	C	D
8104.U2.20	Manillón Berna / <i>Pull handle Berna</i>	400	200	80	25
8104.U3.20	Manillón Berna / <i>Pull handle Berna</i>	600	400	80	25

ACABADOS / *FINISHES*  
Acero Inoxidable (20)

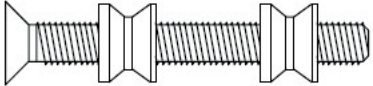
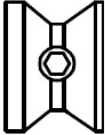
# Kit Accesorios

## KIT MANILLÓN

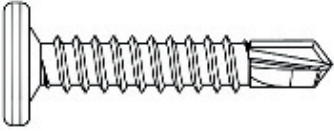
Imagen	Producto	Cantidad
	Almohadillas protectoras de vidrio	2
	Tornillos de fijación de 110 mm M8	2
	Tornillos de fijación de 110 mm M8 con manguitos	2
	Tornillos de fijación de 65 mm M8 con manguitos	2
	Manguito de fijación acanalado en V	2
	Tornillo prisionero de métrica 6	2
	Llave Allen para prisionero de métrica 6	1
	Llave Allen para manguito de fijación	1
	Embellecedor redondo para espárrago M8	2
	Tornillo para metalurgia Métrica 6 Longitud 45 mm cabeza Phillips, para montaje sin traspasar la puerta	2

Para modelos London, Berlín, Shanghai, Sidney, Berna.

# Manillones Modelo 7006

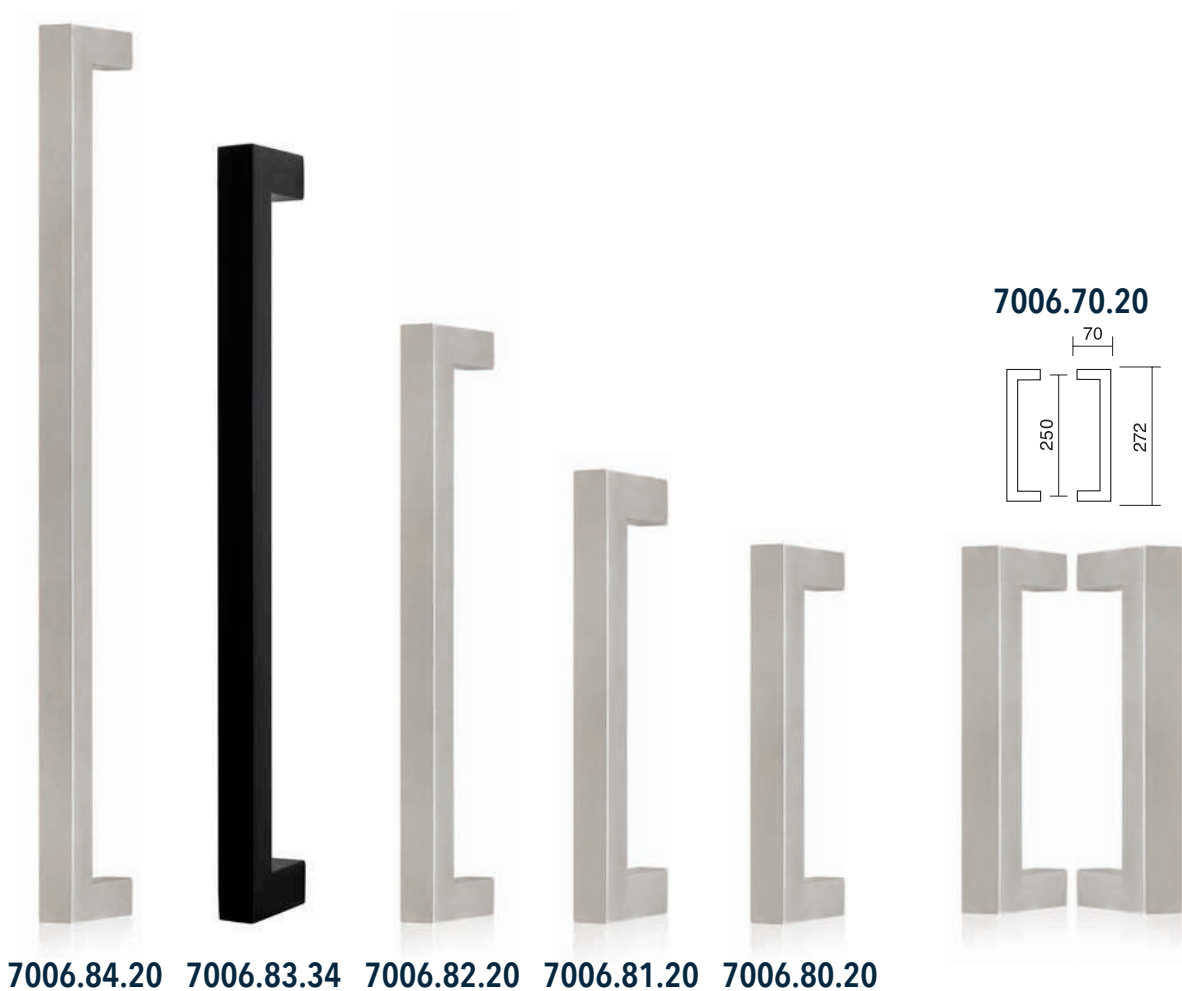

REFERENCIA	CONCEPTO
7006.70	Juego de Manillones 25 x 25 x 250 mm. / Set pull handle 25 x 25 x 250 mm.
7006.71	Juego de Manillones 25 x 25 x 400 mm. / Set pull handle 25 x 25 x 400 mm.
7006.72	Juego de Manillones 25 x 25 x 600 mm. / Set pull handle 25 x 25 x 600 mm.
7006.73	Juego de Manillones 25 x 25 x 1000 mm. / Set pull handle 25 x 25 x 1000 mm.
7006.74	Juego de Manillones 25 x 25 x 1200 mm. / Set pull handle 25 x 25 x 1200 mm.
7006.80	Manillón de 25 x 25 x 250 mm. / Pull handle 25 x 25 x 250 mm.
7006.81	Manillón de 25 x 25 x 400 mm. / Pull handle 25 x 25 x 400 mm.
7006.82	Manillón de 25 x 25 x 600 mm. / Pull handle 25 x 25 x 600 mm.
7006.83	Manillón de 25 x 25 x 1000 mm. / Pull handle 25 x 25 x 1000 mm.
7006.84	Manillón de 25 x 25 x 1200 mm. / Pull handle 25 x 25 x 1200 mm.

## ACABADOS / FINISHES

Acero Inoxidable (20), Negro Mate (34)

# Manivelas Mod. 7003

PLACA ESTRECHA Y ROSETA ESTRECHA

7003.31.20

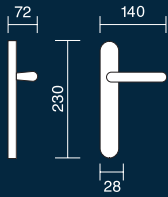

7003.33.34

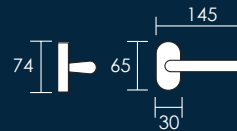

REFERENCIA

CONCEPTO

7003.31

Juego de manivelas placa estrecha con muelle / *Complete lever set on narrow plate with spring*

7003.33

Juego de manivelas roseta ovalada con muelle / *Complete lever set on oval rosette with spring*

ACABADOS / FINISHES

Acero Inoxidable (20), Negro Mate (34)

# Manivelas Mod. 7001

PLACA ESTRECHA Y ROSETA ESTRECHA

**7001.31.20**

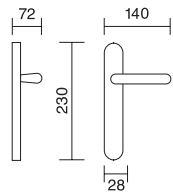

**7001.33.34**



**7001.33.20**

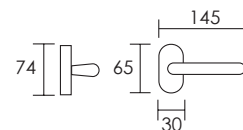

REFERENCIA	CONCEPTO
7001.31	Juego de manivelas placa estrecha con muelle / <i>Complete lever set on narrow plate with spring</i>
7001.33	Juego de manivelas roseta ovalada con muelle / <i>Complete lever set on oval rosette with spring</i>

ACABADOS / FINISHES

Acero Inoxidable (20), Negro mate (34)

# Pomos de Puerta



0500.00.20



7500.00.20



7515.00.20

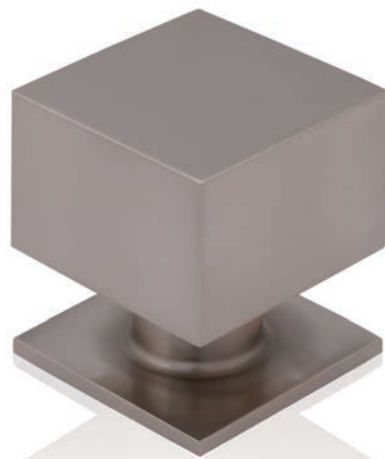

7503.00.20

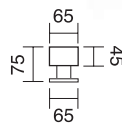

REFERENCIA	CONCEPTO
0500.00	Pomo de puerta / <i>Door knob</i>
7515.00	Pomo de puerta / <i>Door knob</i>

ACABADOS / *FINISHES*  
Acero Inoxidable (20)

7500.00	Pomo de puerta / <i>Door knob</i>
7503.00	Pomo cuadrado de puerta / <i>Door knob square shaped</i>

ACABADOS / *FINISHES*  
Acero Inoxidable (20), Negro mate (34)



# Rosetas

CON BOCALLAVE



7000.14.20



7000.34.20



7000.24.20



7000.44.20



7024.44.20



7850.14.34



0560.00



0560.09

REFERENCIA	CONCEPTO
7000.14.20	Roseta Redonda $\varnothing$ 53 ciega / Rosette $\varnothing$ 53 without key hole
7000.24.20	Roseta Redonda $\varnothing$ 53 c/b Viro / Rosette $\varnothing$ 53 with key hole
7000.34.20	Roseta Redonda $\varnothing$ 53 c/b borja / Rosette $\varnothing$ 53 with key hole type borja
7000.44.20	Roseta Redonda $\varnothing$ 53 c/b viro para cerradura seguridad / Rosette $\varnothing$ 53 with key hole for lock security
7024.44.20	Roseta cuadrada 53 x 53 c/b viro / Square rosette 53 x 53 with key hole
7850.14.20	Roseta Ovalada 65 x 30 c/b viro / Oval rosette 65 x 30 with key hole
0560.00.00	Cuadrillo expansivo 8 x 8 x 65 mm. / Strench out iron 8 x 8 x 65 mm.
0560.09.00	Cuadrillo expansivo 8 x 8 x 90 mm. / Strench out iron 8 x 8 x 90 mm.

## ACABADOS / FINISHES

Acero Inoxidable (20), Negro Mate (34)

# Pomos

---

CON PLACA Y ROSETA

**7000.43.20**

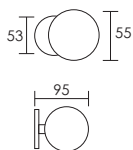

**7000.12.20**

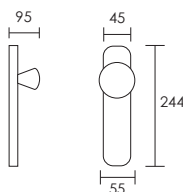

REFERENCIA	CONCEPTO
7000.12	Pomo móvil con placa / <i>Door knob spring on plate</i>
7000.16	Pomo fijo con placa / <i>Door knob fixed on plate</i>
7000.20	Juego de pomos con placa / <i>Complete door knobs sets with spring on plate</i>
7000.43	Pomo fijo con roseta / <i>Door knob fixed on rosette</i>
7000.45	Juego de pomos con roseta / <i>Complete door knobs sets with spring on rosette</i>

ACABADOS / FINISHES  
Acero Inoxidable (20)





Pol. Ind. Les Valletes  
C/ dels Obrers, 19 - Parc. 3 - Apdo. Correos 119  
46192 MONTSERRAT (Valencia)  
Tel. 962 988 002  
Fax 962 998 239

**[nulacvi@nulacvi.com](mailto:nulacvi@nulacvi.com)**  
**[www.nulacvi.com](http://www.nulacvi.com)**